



gesundheit  
mobilität  
patient  
wohlbefinden  
fuss  
service  
freiheit  
hand  
hüfte  
knochen  
technologie  
osteosynthese  
innovation  
knie  
ellbogen

Ihr medizinischer Partner

gesundheits  
 mobilität hand  
**patient**  
 wohlbefinden  
 fuss knie  
 ellbogen  
 service  
 freiheit  
 hüfte knochen  
 technologie  
 osteosynthese  
 innovation

 KeriMedical



**TOUCH®**  
 Trapezförmige Daumensattelgelenk-  
 Prothese mit doppelter Mobilität

**Motec®**  
 Modulare Handgelenkprothese

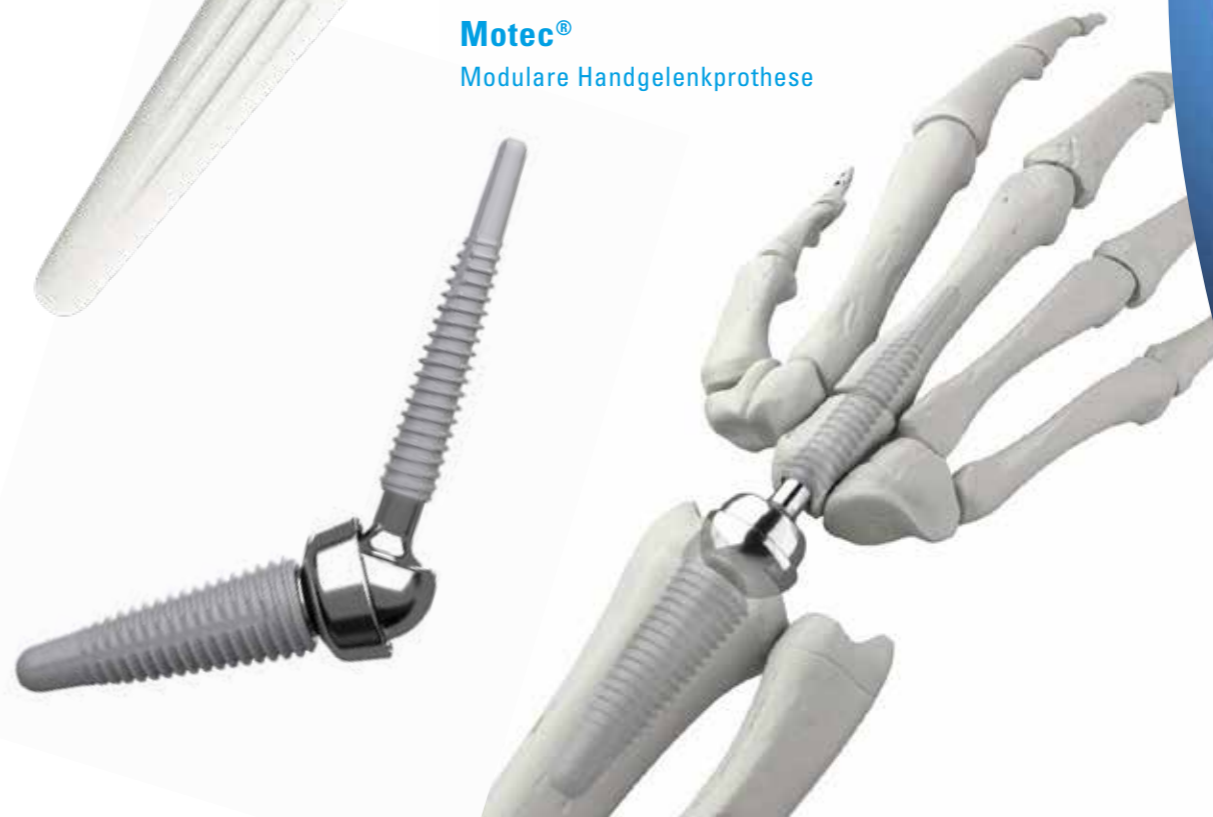



### KeriFlex®

Fingergelenk-Implantate  
PIP - MCP aus Silikon

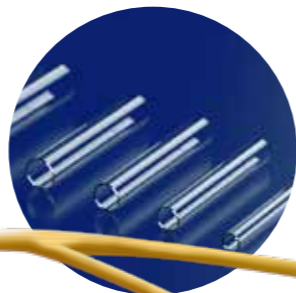

### Reaxon® Nerve guide Reaxon® Direct

Unterstützung der Nervenregeneration  
und Nervenleitschiene



### KeriFuse®

Intramedulläres  
Arthrodesenimplantat DIP - IP



### KeriFix®

Einschlag-Anker



### KeriLock®

Schraubanker



NEWCLIP-TECHNICS

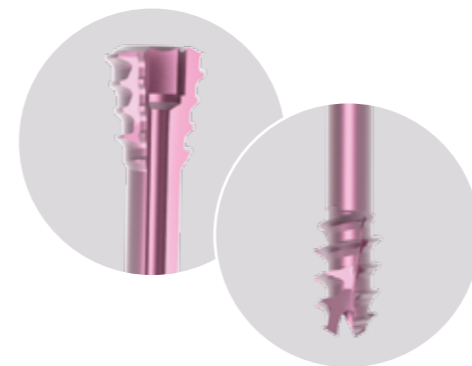

### Handmotion



### Initial S™ Hand

Erstes Instrumenten-Einweg-Kit



### Kemis®

Einwegmesser für verschiedene  
minimal-invasive Chirurgie (MIC)

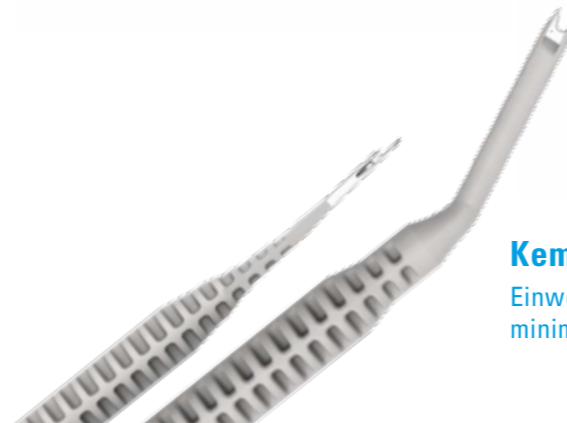

NEWCLIP-TECHNICS



### Initial R™ Xpert 2.4 Radius Distal Palmarplatten



Patientenspezifische  
Schnittblöcke für  
den distalen Radius



NEWCLIP-TECHNICS



### Alians Ulna 3/3 Verkürzungsosteotomie

### Alians Fragment Specific





### RadioLuscent

Wrist Fixator

Steriler Handgelenkfixateur

### M2

MultiPlanar MiniRail™ System



### Calcaneal

External Fixator



The power of minimally invasive surgery

### miCUTone®

Steriler Einwegmotor



NEWCLIP-TECHNICS



Perkutane Fräsen

NEWCLIP-TECHNICS



### Initial S™ Foot

Erstes Instrumenten-Einweg-Kit



### Footmotion

Vorderfuss

Komplettes Schraubensortiment



### Klammern verschiedener Grössen



NEWCLIP-TECHNICS



### Initial A™

Erstes Fibula Einweg-Kit



### Initial F™ MTP

Erstes MTP1 Einweg-Kit



NEWCLIP-TECHNICS



**Footmotion**  
Plattensystem

Vollständiges Sortiment an Platten für die Chirurgie des Vorder- und Mittelfusses



**Plantar Lapidus**



**Flatfoot**

**ACTIV FUSE**  
Fussknöchel-Arthrodesese

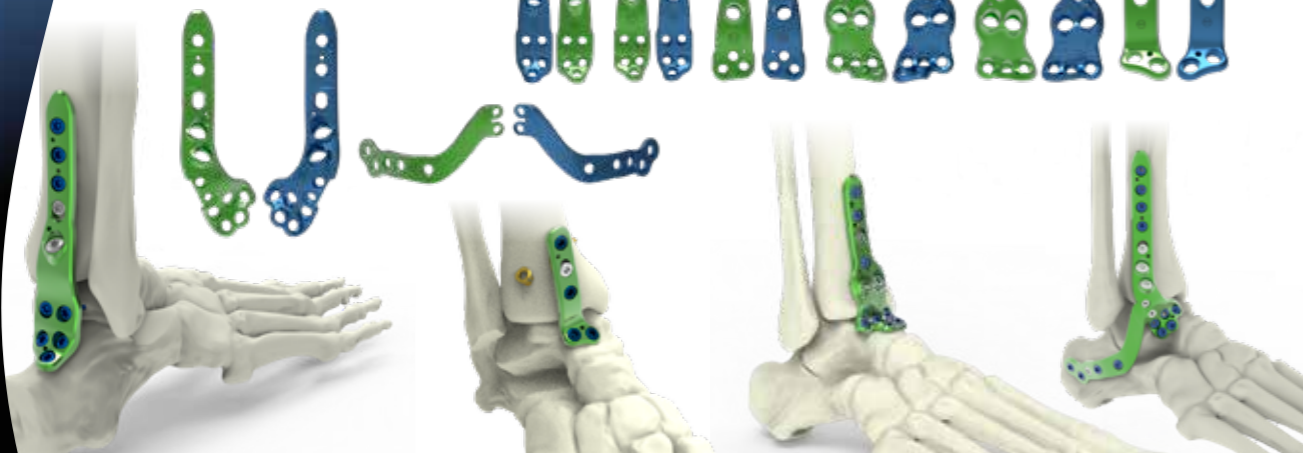

NEWCLIP-TECHNICS



**Activmotion S**  
Aufklappende Tibiaosteotomie



**Activmotion S**  
Tibiaosteotomie mit medialem und lateralem Verschluss



**Activmotion S**  
Aufklappende und zuklappende Femurosteotomie



**Activmotion S Ligamento**



Patientenspezifische Schnittblöcke für Femur und Tibia





**ORTHOFIX**  
ORTHOPEDICS

### Galaxy Fixation<sup>®</sup> System

Externes modulares Befestigungssystem



### Galaxy Fixation<sup>™</sup> Elbow System Einweg-Kit

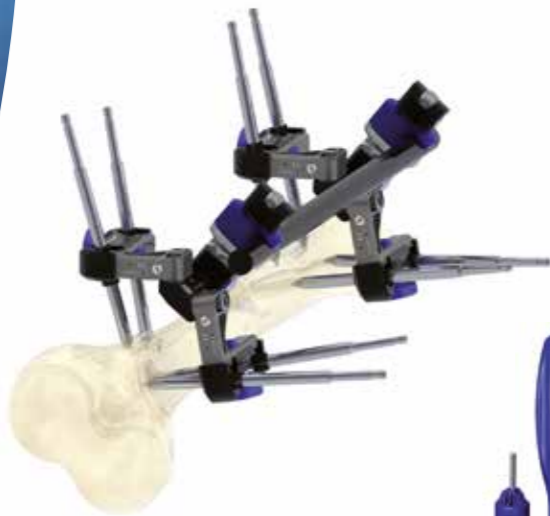

### Galaxy Unyco<sup>™</sup> System

Monokortikaler Aufsatz für Damage Control



**ORTHOFIX**  
ORTHOPEDICS



### TrueLok<sup>™</sup> Ring Fixation System

Externer Ringfixateur



### TL-HEX

TrueLok Hexapod System<sup>®</sup>



### TL-HEX Trauma

TrueLok Hexapod System<sup>™</sup>







### Hüftprothesen

Zementierte und nicht zementierte Double Mobility



### Chimaera

Hip Fracture System\*

Hüftfraktursystem  
Trochantärer Nagel



### Fitbone

Intramedullary Lengthening System

Verlängerungsmarknagel

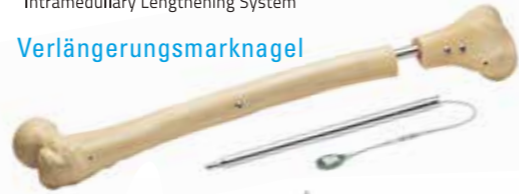

### Oscar Pro

System

Ultraschallinstrument zur  
revision von Endoprothesen



XCaliber™  
Fixator



LRS  
Limb Reconstruction System™



XCaliber™  
Meta-Diaphyseal Fixator

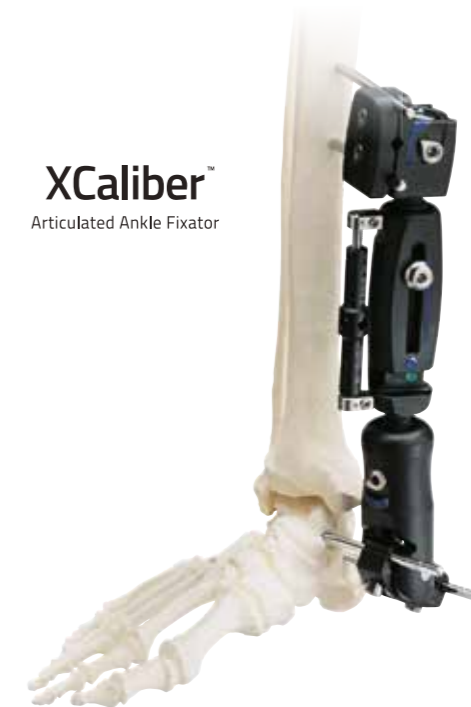

XCaliber™  
Articulated Ankle Fixator



NEWCLIP-TECHNICS



**Alians Ellenbogen**



**HYLA**  
Hybrid Latarjet



**Alians Schlüsselbein**

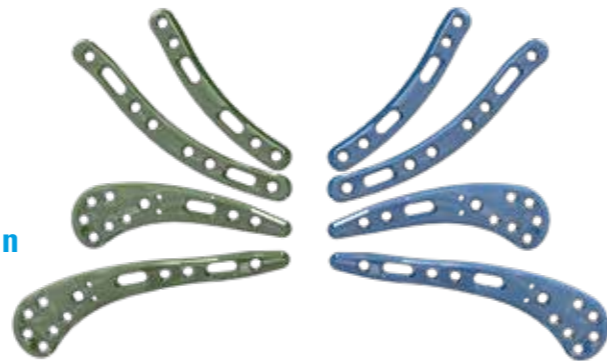
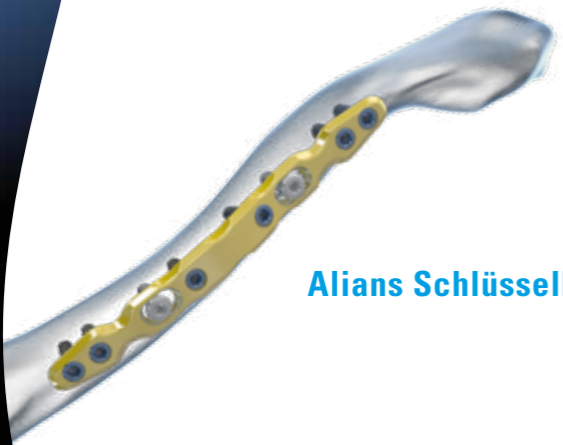

**ORTHOFIX**  
ORTHOPEDICS

**LRS**  
Limb Reconstruction System™  
**Paediatric**



**Eight-Plate**  
Guided Growth System®

**Galaxy Fixation**  
System  
Steriles Set für Kinder



**MJ-Flex**  
The New Metaizeau Nail™





TBF

**F-Phoenix<sup>DBM</sup>**  
Knochen-Allografte  
(osteinduktiv)



**Phoenix<sup>®</sup>**  
Knochen-Allografte (osteokonduktiv)



BonAlive<sup>®</sup>

**BonAlive<sup>®</sup> granules**

Knochen-Kavitätsfüller für die Heilung von Knocheninfektionen sowie für die Anwendung bei orthopädischen, traumatologischen, Wirbelsäulen- und Mastoideingriffen

**BonAlive<sup>®</sup> putty\***

Bioresorbierbares Glas zum Auffüllen von Zwischen- und Knochenhöhlräumen

\*Bakterizide Eigenschaft nicht bewiesen



**ActivaPin™**  
**ActivaNail™**  
**ActivaScrew™**  
 Bioresorbierbar

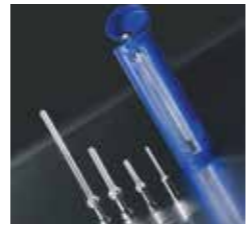

**Activa IM-Nail™**  
 Bioresorbierbarer und  
 intramedullärer Nagel



**Wiederverwendbarer Bohrer**



Modular



Monobloc

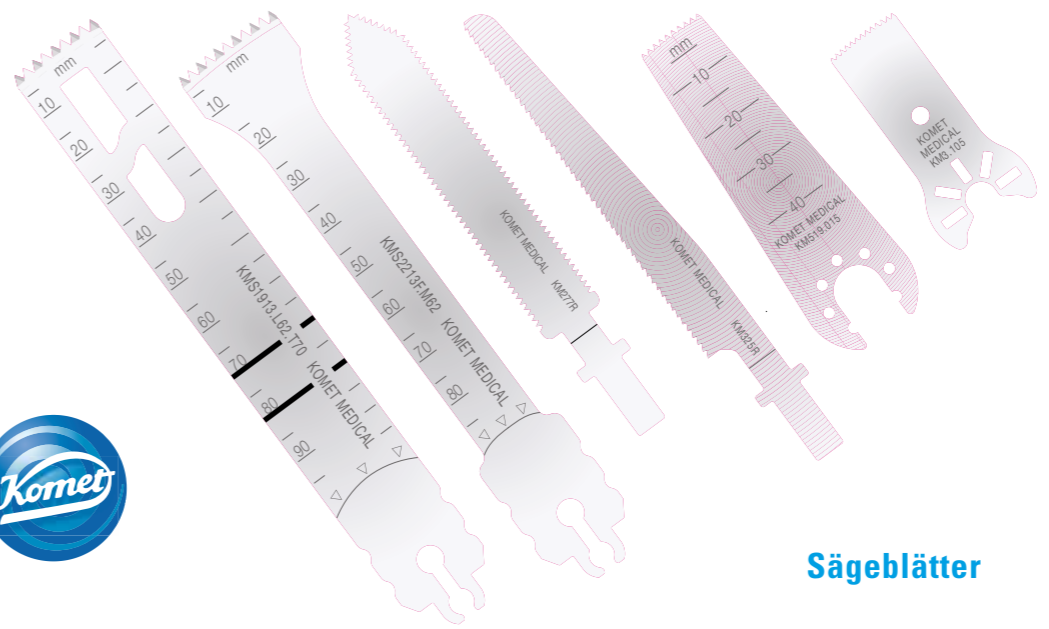

**Sägeblätter**





**Kirschnerdrähte und  
Steinmann-Nagel**

**Spickdrahträger**



**Spickdrahtröhre**

**Cerclage-Draht**



**Schablone**

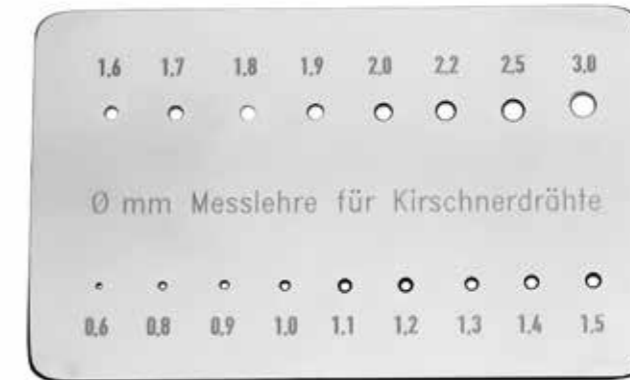

**Zentimetermass**





Steriler dünner  
Stift mit Lineal

### Sterile Hautstifte

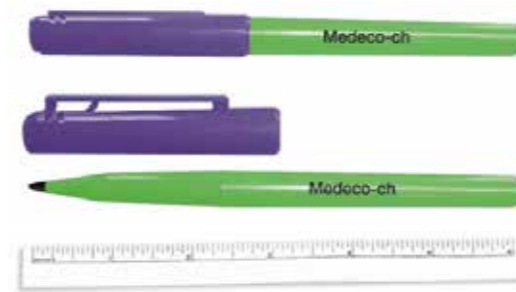

Steriler Standardstift  
mit Lineal

### Sterile Etiketten und Permanentstift

<b>Bacitracin</b> Amt _____ Exp _____
<b>Cocaine _____ %</b> Amt _____ Exp _____
<b>DYE</b> Amt _____ Exp _____
<b>Epinephrine</b> Amt _____ Exp _____
<b>Heparin _____ units</b> Amt _____ Exp _____
<b>Heparinized Saline</b> _____ units/ml Amt _____ Exp _____



Personalisiert

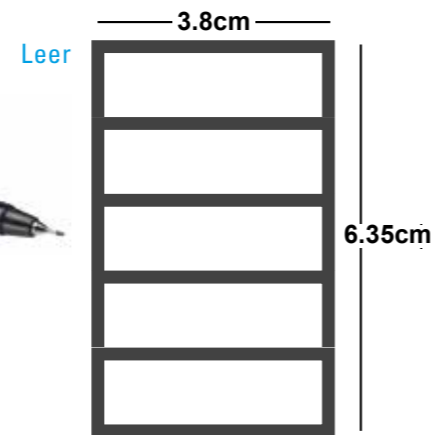

Verschiedene Modelle vorrätig, kontaktieren Sie uns für mehr Informationen.

Besuchen Sie unsere Website für weitere Informationen:  
[www.medeco-ch.com](http://www.medeco-ch.com)



## Medeco-ch:

### Ein telefonischer Informationsdienst

steht Ihnen 24 Stunden täglich zur Verfügung, um unter der folgenden Telefonnummer alle Fragen zu beantworten: +41 79 434 91 60

### Sie haben drei Möglichkeiten, Bestellungen zu tätigen:

- **telefonisch:** +41 22 307 01 70
- **per Fax:** +41 22 362 11 85
- **per E-Mail:** [info@medeco-ch.com](mailto:info@medeco-ch.com)

Alle bis 17 Uhr eingegangenen Bestellungen werden je nach Lagerverfügbarkeit am darauffolgenden Tag geliefert werden.

Medeco-ch Sàrl  
Route de Trélex 8  
1266 Duillier  
Schweiz  
Telefon: +41 22 307 01 70  
Fax: +41 22 362 11 85  
[info@medeco-ch.com](mailto:info@medeco-ch.com)  
[www.medeco-ch.com](http://www.medeco-ch.com)

# Ihre Zufriedenheit ist unsere Motivation